

Più piano HV Datenblatt

Occhio Più Strahler sind als Aufbauvariante (alto und alto²), als Einbauvariante (piano und piano in) und als Schienenstrahler (track) erhältlich.

Dank des einzigartigen Kugelkalottenprinzips sind die Più piano Strahlerköpfe rundum frei ausrichtbar (Più piano 30°, Più piano in 20°). Es stehen verschiedene Varianten für unterschiedliche Einbaulösungen zur Wahl. Die magnetisch fixierten cover sind charakteristisch für die Deckeneinbauversionen. Die rahmenlosen Modelle sind sowohl mit Einbauplatte als auch zur Montage auf rückseitig zugänglichen Panels erhältlich.

Die verschiedenen optischen Komponenten (Inserts) können jederzeit über einen einfachen Mechanismus getauscht bzw. neu zusammengestellt werden.

Dank dem Occhio 'Smart Source' Konzept besteht die freie Auswahl der vier Lichtquellen Hochvolt-Halogen (HV), Niedervolt-Halogen (NV), Metallampf-Halogen (CDM) und „next generation“ Hochleistungs-LED.

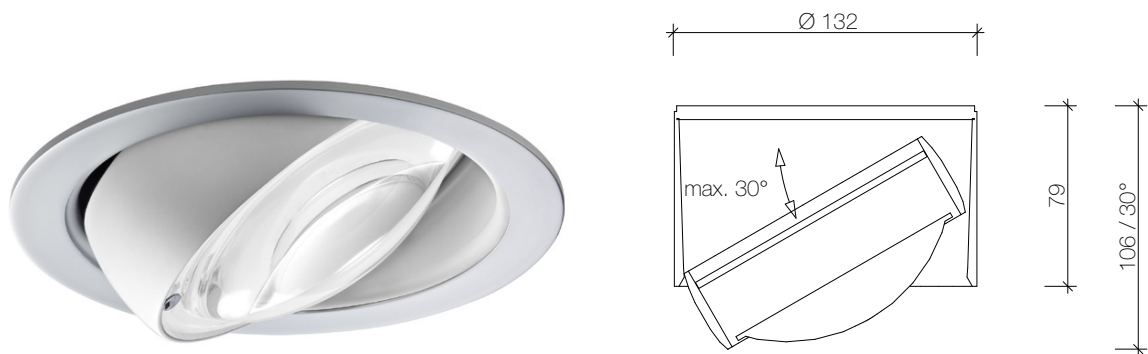

Material Leuchte Aluminium, Messing, Stahl verchromt oder lackiert	Oberfläche head chrom, chrom matt, schwarz glänzend, schwarz matt, weiß glänzend, weiß matt	Oberfläche cover chrom, chrom matt, schwarz glänzend, schwarz matt, weiß glänzend, weiß matt	Drehbereich body 360°	Lichtwirkungen siehe Datenblatt S. 2	Vorschaltgerät nicht notwendig Betrieb an 230 V AC
Material inserts optischer Kunststoff, Glas	Oberfläche tube schwarz matt, weiß matt		Beweglichkeit head 30° (mit Anschlag)	Dimmung mit handelsüblichem Phasen- oder Phastenabschnitt- dimmer	
			Gewicht max. 1,1 kg		

Leuchtmittel HV

Leistung	P	60 W	48 W	Farbtemperatur	T	2800 K
Lichtstrom	ø	980 lm	740 lm	Farbwiedergabeindex	CRI	Ra 100
Wirkungsgrad	η	16 lm/W	15 lm/W	Effizienzklasse	EEK	D
Mittlere Lebensdauer	t	2000 h		Fassung		G9
				Osram Bezeichnung		Halopin Eco
				Empfohlener Einsatz		Wohnen



Più piano Lichtwirkungen HV

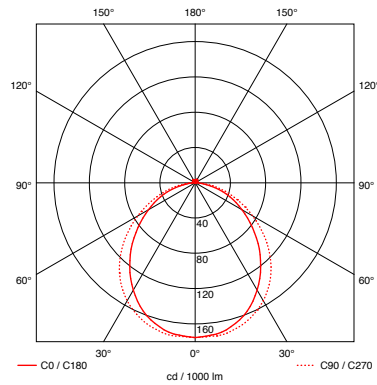
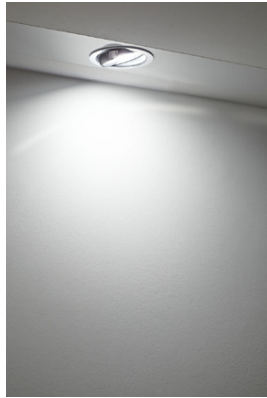

Più B

diffuses Licht
Leuchtenwirkungsgrad ca. 49 %

insert: satiniertes Glas

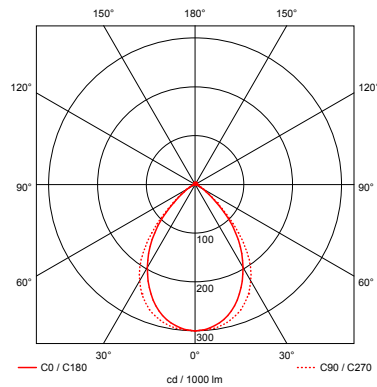
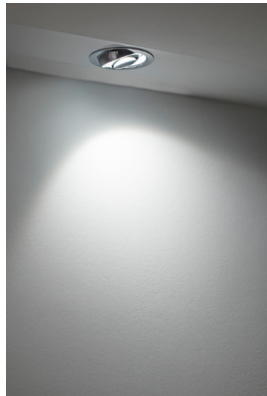

Più C mit satiniertem Glas

gerichtetes Licht
mit sanfter Aufweitung des Lichtkegels
Leuchtenwirkungsgrad ca. 53 %
Lichtkegel ca. 90°

insert: satiniertes Glas
 Linse

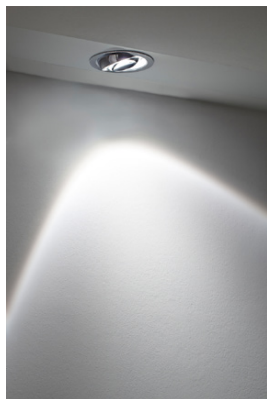

LVK ähnlich Più C

Più C mit soft edge Glas

gerichtetes Licht
mit weichen Konturen des Lichtkegels
Leuchtenwirkungsgrad ca. 54 %
Lichtkegel ca. 80°

insert: soft edge Glas
 Linse

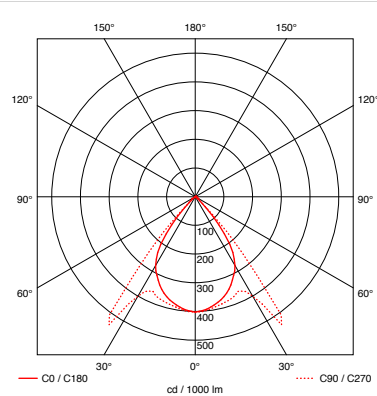
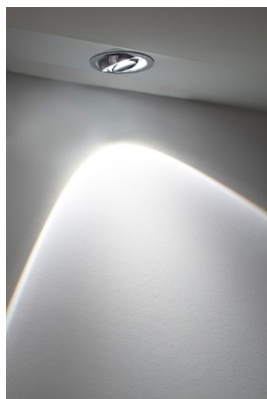

Più C



gerichtetes Licht
Leuchtenwirkungsgrad ca. 59 %
Lichtkegel ca. 80°

insert: Linse

Più piano HV Artikelnummern

Farbcode

Artikelnummer mit Farbcode ___ (head + tube)
ergänzen:













tube (innen) — 
head — 

<u>C</u> <u>C</u>	head	tube
<u>M</u> <u>M</u>	chrom	<u>W</u> weiß matt
<u>C</u> <u>B</u>	chrom matt	<u>S</u> schwarz matt
<u>M</u> <u>W</u>	weiß glanz (bianco)	
<u>C</u> <u>N</u>	weiß matt	
<u>M</u> <u>S</u>	schwarz glanz (nero)	
	schwarz matt	

HV-Halogen











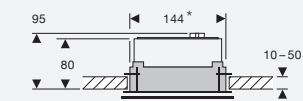
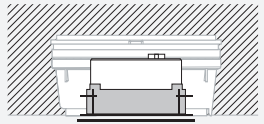

Hochvolt-Halogen Eco G9

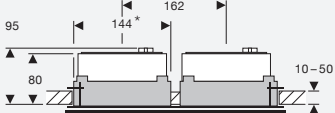
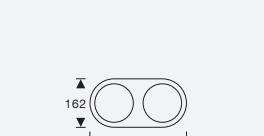
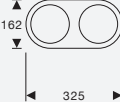
max. 60 W (exkl. Leuchtmittel)

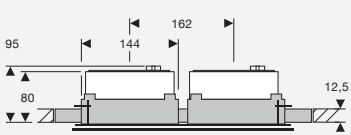
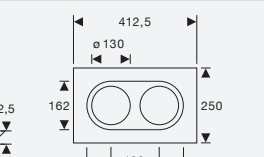
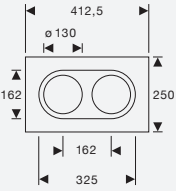
<p>head</p> <p>B</p>  <p>C</p> 	<p>Più piano HV</p> <hr/> <p>B satiniertes Glas diffus</p>  <p>C Linse 80°</p> 	<p>Artikelnr.</p> <hr/> <p>1P1289 __ mit Farbcode ergänzen</p> <p>1P1288 __</p>	
<p>inserts optional</p>	<p> Filter rot</p> <p> Filter grün</p> <p> Filter blau</p> <p> Filter gelb</p> <p> Filter magenta</p>	<p>8K602R</p> <p>8K602G</p> <p>8K602B</p> <p>8K602Y</p> <p>8K602M</p>	<p> satiniertes Glas</p> <p> soft edge Glas</p> <p>nur für Version C</p> <p>8K6040</p> <p>8K6035</p>
<p>light source</p> <p>+ immer mitbestellen</p>	<p> HV-Halogen Eco G9 48 W</p> <p> HV-Halogen Eco G9 60 W</p>	<p>5D0048C</p> <p>5D0060C</p>	

Più piano

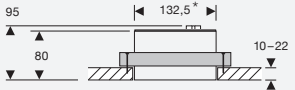
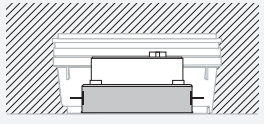
Einbauvarianten (cover / seamless)

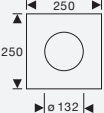
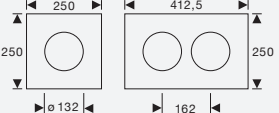
mount.	 Einbauring + cover	Artikelnr.		
+ immer mitbestellen		chrom 1M 11 00 C chrom matt 1M 11 00 M weiß glanz (bianco) 1M 11 00 B weiß matt 1M 11 00 W schwarz glanz (nero) 1M 11 00 N schwarz matt 1M 11 00 S	 	
		chrom 1M 12 00 C chrom matt 1M 12 00 M weiß glanz (bianco) 1M 12 00 B weiß matt 1M 12 00 W schwarz glanz (nero) 1M 12 00 N schwarz matt 1M 12 00 S	 	
	 doppio Einbauplatte + cover	chrom 1M 13 00 C chrom matt 1M 13 00 M weiß glanz (bianco) 1M 13 00 B weiß matt 1M 13 00 W schwarz glanz (nero) 1M 13 00 N schwarz matt 1M 13 00 S	 	
	 Panel seamless Haltering für Panel 1M 30 00  Einputzring 1M 20 00 (für Kaiser KompaX3 Eingussgehäuse)  Einbauplatte seamless Einbauplatte seamless 1M 21 00  doppio Einbauplatte seamless 1M 22 00	 		
Hohlraumdecke (Montage rückseitig)		Betondecke verputzt, kein Sichtbeton (Kaiser KompaX3 mit Mineralfaserplatte)		
Hohlraumdecke (Faserzementplatte mit Haltering)				

*Ausschnittmaß